

C

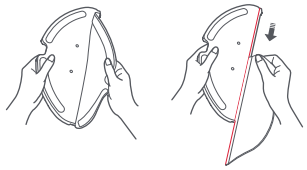

C6

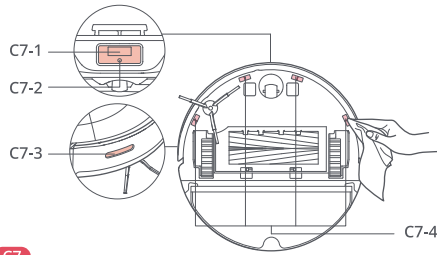

C7

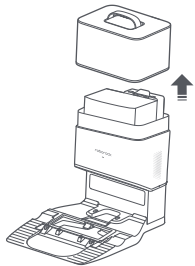

C8

C8-1

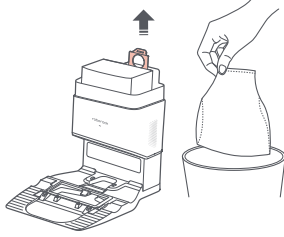

C8-2

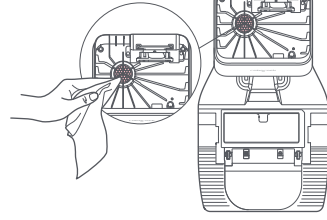

C8-3

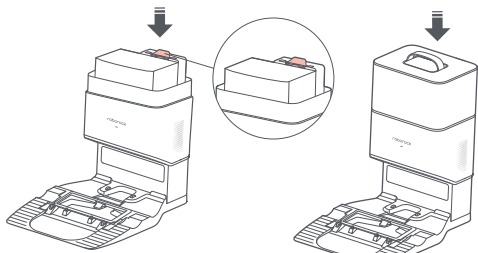

C8-4

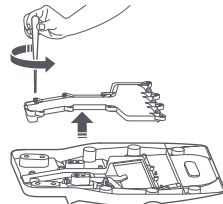

C9

C9-1

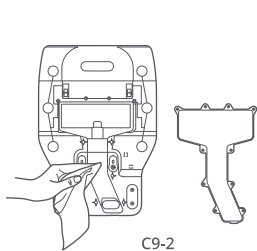

C9-2

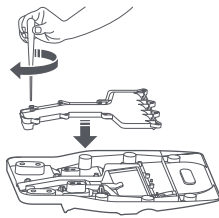

C9-3

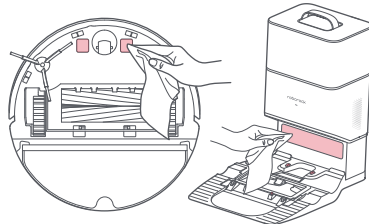

C10



A

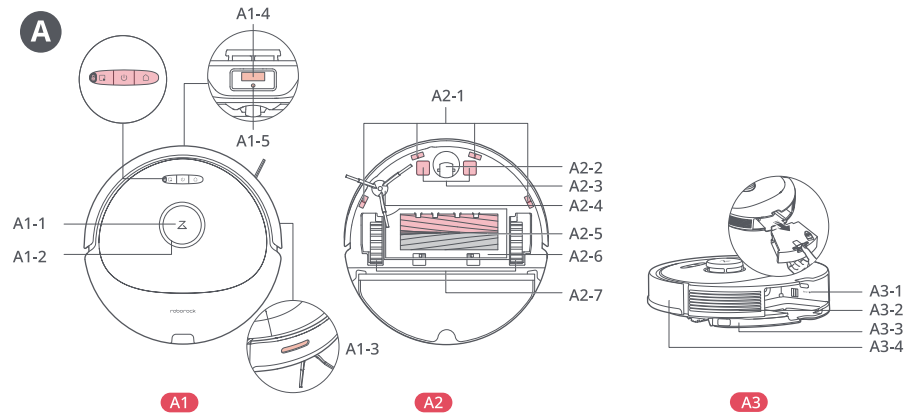

A1

A2

A3

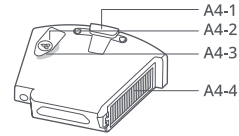

A4

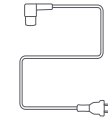

A5

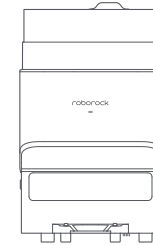

A8

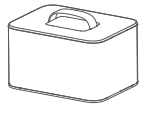

A9

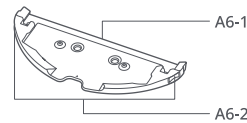

A6



A7

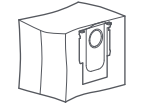

A10

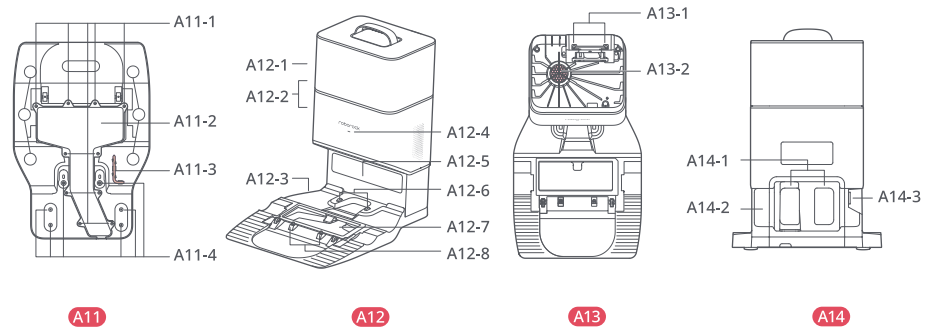

A11

A12

A13

A14

B

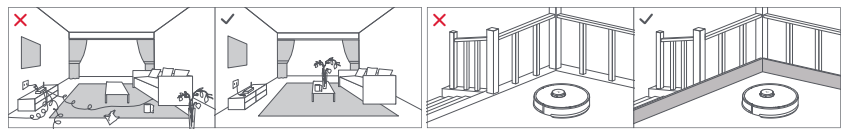

B1 B1-1 B1-2

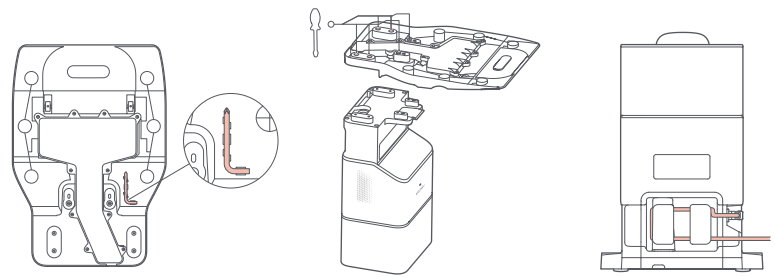

B2 B2-1 B2-2 B2-3

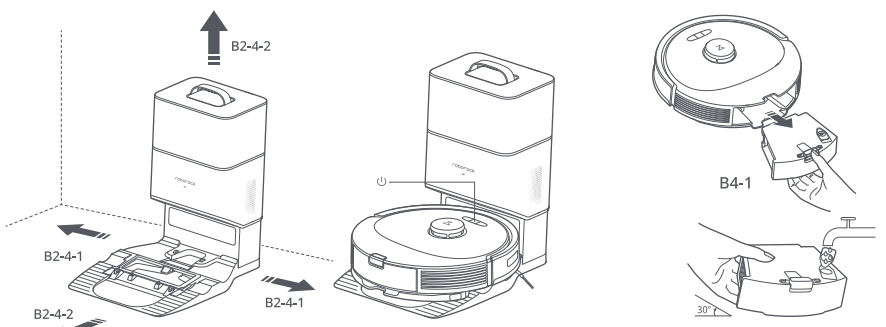

B2-4 B3 B4-1 B4-2

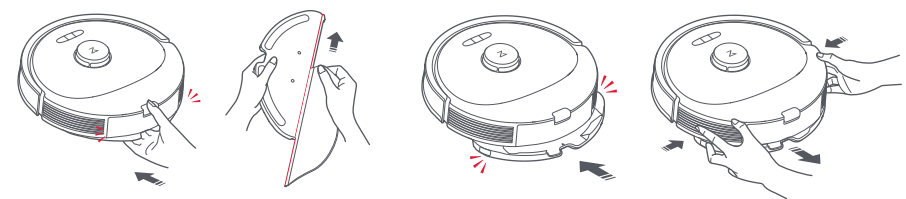

B4-3 B4-4 B4-5 B4-6

C

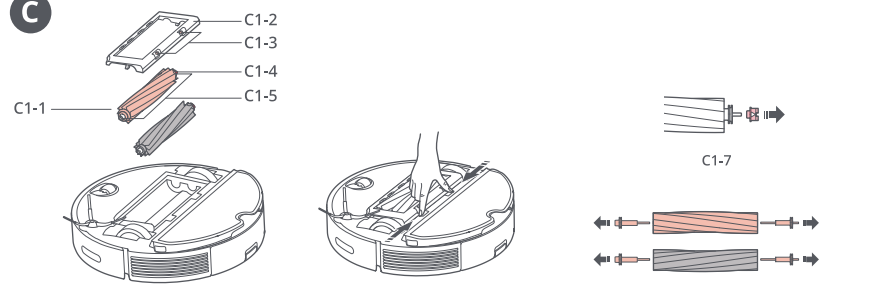

C1 C1-1 C1-2 C1-3 C1-4 C1-5 C1-6 C1-7 C1-8

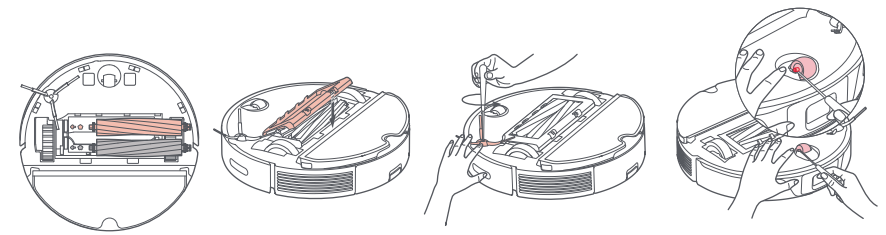

C2 C3

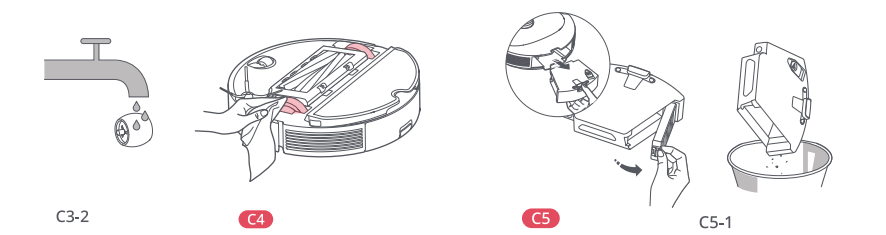

C4 C5 C5-1

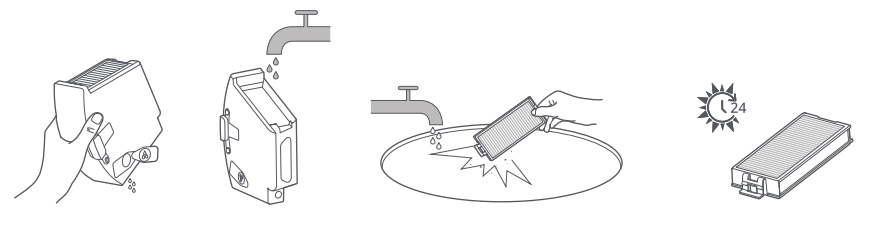

C5-2 C5-3 C5-4 C5-5