

Roborock handheld cordless vacuum cleaner

instruction manual



• Safety Information	1
• Product introduction	4
• Parts List	5
• Screen display	6
• Buttons	7
• Installation	8
• Use	9
• Maintenance	13
• Basic parameters	22
• Troubleshooting	23
• EU Declaration of Conformity	24
• WEEE Information	28
• Warranty Information	29

Safety Information

Read this manual carefully before use, and retain it for future reference.

Usage Restrictions

- Do not use this vacuum in outdoor, commercial, or industrial environments. It is intended for home and in-car use only.
- Do not store the vacuum anywhere in the car to avoid high or low temperatures affecting its battery life.
- Do not use the vacuum in environments with high humidity, or temperatures above 40°C or below 4°C.
- Children should be supervised to ensure that they do not play with the appliance.
- This appliance is not intended for use by persons (including children) with reduced physical, sensory or mental capabilities, or lack of experience and knowledge, unless they have been given supervision or instruction concerning use of the appliance by a person responsible for their safety.(CB)
- This appliance can be used by children aged from 8 years and above and persons with reduced physical, sensory or mental capabilities or lack of experience and knowledge if they have been given supervision or instruction concerning use of the appliance in a safe way and understand the hazards involved. Children shall not play with the appliance. Cleaning and user maintenance shall not be made by children without supervision.(EU)
- Keep hair, loose clothing, fingers, and all parts of body away from openings and moving parts.
- While using an electric brush head, keep limbs and pets away from the rotating brush

Safety Information

heads to avoid injury.

- Do not touch the power supply, nor operate the product with wet hands to prevent injuries.
- Do not vacuum any liquids (such as water, cola).
- Do not vacuum any burning or smoking substances (such as non-extinguished cigarette butts).
- Do not vacuum any hard or pointy objects (such as building materials, glass, and nails).
- Please use this product in accordance with the instructions in the User Manual. Users are responsible for any loss or damage that may arise from improper use of this product.
- This product is only to be used in areas below 3,000 meters above sea level.

Battery & Charging

WARNING

- This product contains batteries that are only replaceable by skilled persons.
- This product can only be charged using a BTC03RR power supply provided with the product.
- Do not use any third-party batteries, power adapters or docking stations.
- Do not disassemble, repair or modify the battery, power adapter or the docking station.

Safety Information

- Do not charge the vacuum or install the docking station near heat sources or in humid areas (such as radiators or bathrooms).
- Do not wipe the adapter or the docking station with a wet cloth, nor touch them with wet hands.
- If the power cord is damaged or broken, immediately stop using it and contact after-sales service.
- If the vacuum is not going to be used for an extended period of time, please fully charge it, unplug its power supply, and place it in a cool and dry place. Make sure that you recharge it once every three months to avoid the battery to over-discharge.

Transportation

- It is recommended to transport the vacuum in its original packaging.

Note

- Rinse the filter at least once a month with tap water. For details please refer to Maintenance.

Product introduction

Vacuum

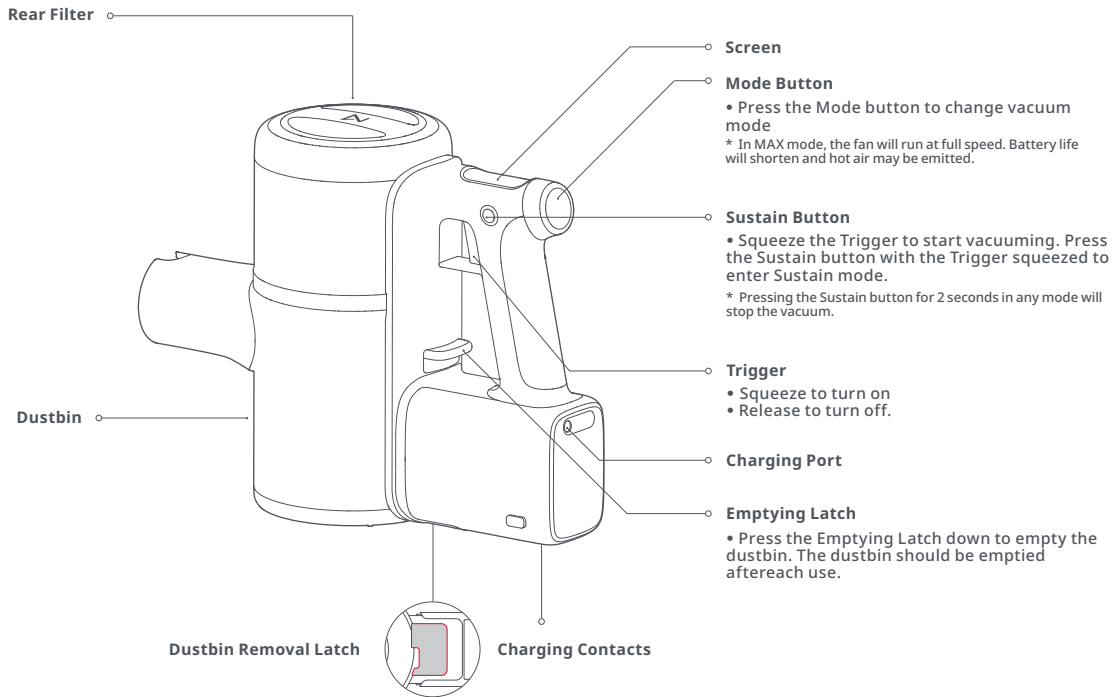

Parts List

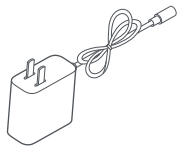

Power Supply



Crevice Tool



Dusting Brush

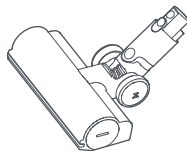

Carpet Brush

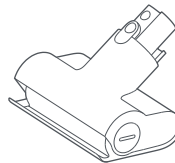

Motorized Mini-Brush



Baton



Flex Tube

Screen display

This Roborock cordless vacuum is equipped with a 1.3-inch OLED display that shows relevant information in real-time.

Standby and operating modes

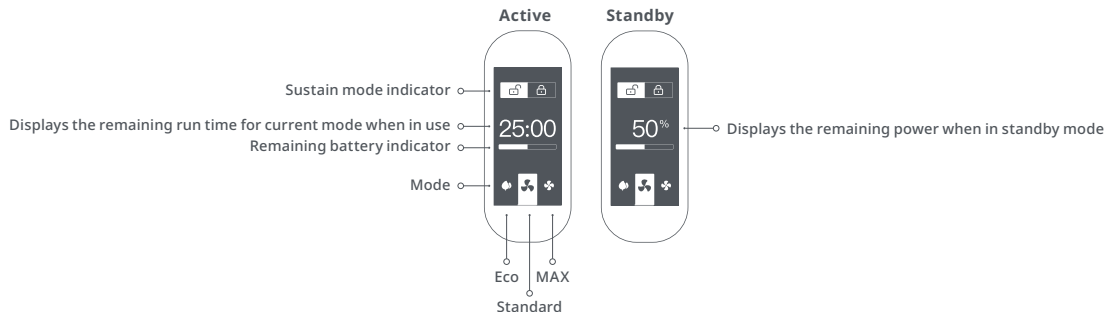

Notes:

1. The run time indicator will appear after several seconds of use.
2. Remaining run time is for reference only and may be different to actual run time.

Charging

When the battery is charging, a charging animation will show alongside the current battery level. The screen will turn off automatically after 1 minute of inactivity.

Error

If an error occurs while the vacuum is in operation, the screen will show an error message. See Troubleshooting for details.

Language selection

Press the Mode button for 10 seconds to enter the language selection interface. Press the Mode button to scroll through language options. Squeeze the Trigger to confirm a language and exit language selection.

Buttons

Sustain Button

Press the Sustain button to enter Sustain mode. The Sustain icon will appear on screen. Squeeze the trigger while in Sustain mode to start the vacuum and enable it to run continuously. In Sustain mode, the vacuum will not stop when the trigger is released. Press the Sustain button again to disengage Sustain mode and stop vacuuming.

You can also enable the vacuum to run continuously by first pressing the trigger then pressing the Sustain button.

Notes:

1. Squeezing the trigger while the vacuum is already running continuously in Sustain mode will have no effect.
2. Pressing the Sustain button for 2 seconds in any active mode will stop the vacuum.

Trigger

Squeeze the trigger to start vacuuming.

* Press the Sustain button while the vacuum is running continuously to disengage Sustain mode.

Releasing the trigger will stop the vacuum and enter it into Standby mode, unless it is in Sustain mode. The screen will turn off automatically after 30 seconds of inactivity and the vacuum will automatically turn off after 1 minute of inactivity.

Notes:

1. The vacuum will stop running when charging.
2. Insufficient power or other errors may cause the vacuum to fail. See Troubleshooting for details.

Mode Switch button

When the vacuum is on, press the Mode button to switch between Eco, Standard, or MAX modes. The respective icon will be highlighted on-screen.

Note:

The vacuum will return to Standard mode after turning off or when charging.

Installation

Vacuum and accessories setup

Option 1 Connect the Baton to the vacuum, then attach an accessory.

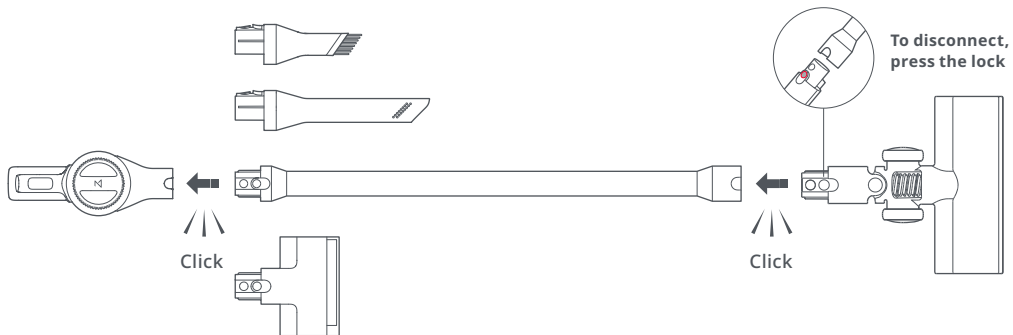

Option 2 Connect the vacuum directly to an accessory

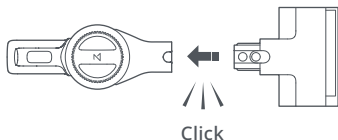

Option 3 Connect the flex tube to the vacuum, then attach an accessory.

* Motorized accessories such as the motorized mini-brush or Carpet brush cannot be used with the flex tube.

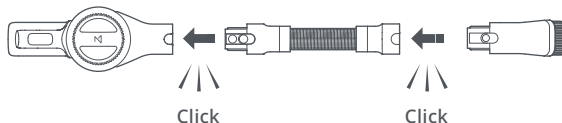

Use

Charging

When the battery is charging, a charging animation will show alongside the current battery level.

The screen will turn off automatically after 1 minute of inactivity.

Notes:

1. When charging, the screen image faces the user for easy viewing.
2. When charging, the vacuum will enter Charging mode and stop all other functions.
3. The battery temperature will increase after continuous use in MAX mode. As a result, recharging may take longer.
4. When battery levels are very low, the vacuum screen will only light up after a period of charging.

Before using the vacuum, read the " Safety Instructions" in this user manual

Note:

Make sure the Power Supply is firmly inserted into the power socket.

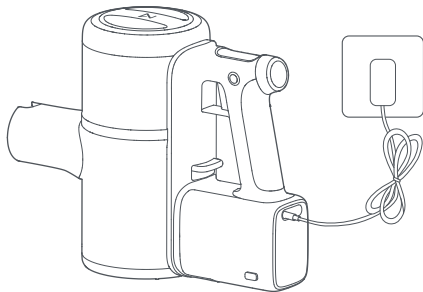

Charge with the Power Supply

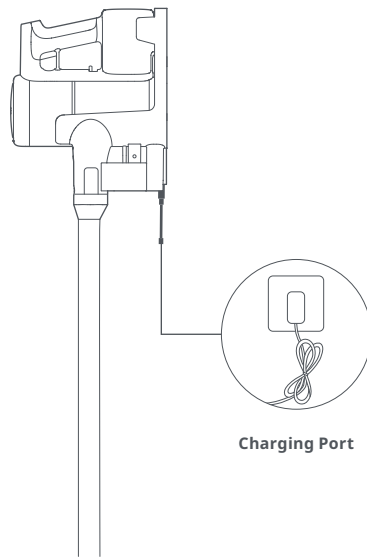

Charging Port

Charge with the charging stand

Use

Using the vacuum

1. When using the Carpet brush or motorized mini-brush on the vacuum cleaner, the surfaces of some fabrics may pill or be difficult to vacuum. If this occurs, it is recommended that you use the dusting brush or crevice tool to vacuum these surfaces.
2. Before vacuuming shiny floors such as parquet or tiles, ensure there is no hard debris trapped the Carpet Brush to avoid scratches.
3. Before using the vacuum, ensure that the Dustbin, Multi-Cyclone Assembly, and filters have been properly installed.
4. Do not block the exhaust outlet when vacuuming.
5. This vacuum is designed for domestic use. Flour and other fine dust should only be vacuumed in small amounts.
6. To avoid damage to the vacuum or the floor, do not use the vacuum to clean up hard or sharp objects such as toys and nails.
7. Be aware of your environment as you vacuum, especially around stairs and windows.
8. To avoid accidental fall damage, avoid placing the vacuum on raised surfaces such as desks and shelves, or leaning it against other objects.
9. The rotation of the Carpet Brush may leave an unevenly polished floor. This can be resolved by wiping with a damp cloth or polishing with floor wax.

Auto Shutoff

1. If any rotating parts get jammed, the vacuum will shut off automatically. Clear the jam to continue vacuuming.
2. If the motor gets too hot, the vacuum will automatically shut off. Wait until the temperature returns to normal before continuing.

Keep the Brush Clear

1. Electric brushes will automatically stop if jammed by dirt or long fibers during use. If this occurs, clear them before continuing.
2. Detach the brush from the vacuum before cleaning. Avoid turning the vacuum on when no brush is attached.

Precautions:

1. Beware of sharp objects trapped in the roller.
2. If debris trapped in the roller cannot be easily extracted, see the "Clean Roller" section for details on removing the roller.

Use

Brush Accessory Uses

1. Crevice Tool:

Narrow crevices, including skirting boards, corners, and stairs.

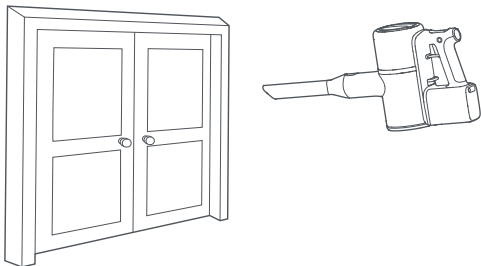

2. Dusting Brush:

Dusting sofas, chairs, and other soft furnishings, and flat surfaces such as desks and shelves.



Tip:

The Dusting Brush can also be used on its own to dust the vacuum and other items around the house.

3. Motorized Mini-Brush:

Cleaning dust from beds, sofas, and soft furnishings to avoid mites.

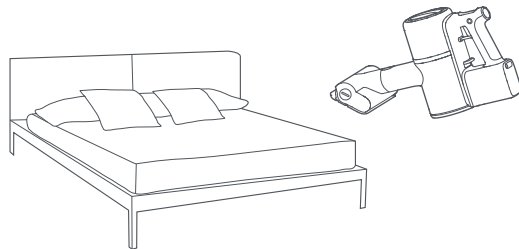

Use

Brush Accessory Uses

4. Carpet Brush:

Connect to the Baton for cleaning short and medium-pile carpets. Carpet Brush can also be used on easily scratched floor surfaces.

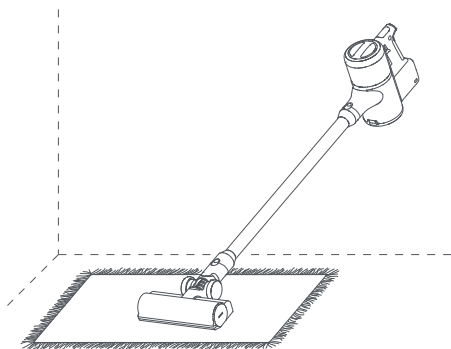

Carpet Boost is automatically activated when the Carpet Brush is installed. When a carpet is detected, suction automatically increases to MAX for a deeper clean. It will return to the previous mode when carpet is no longer detected.

Notes:

1. Carpet Boost will not activate when vacuuming in MAX mode.
2. Use the Carpet Brush for easily scratched floor surfaces.

5. Flex Tube:

Connect to Dusting Brush or Crevice Tool to clean small or narrow spaces such as drawers and car interiors.

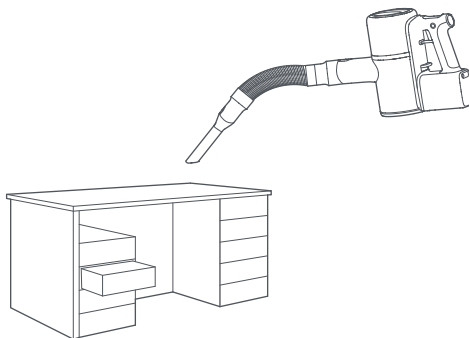

Maintenance

Product Warranty

1. Only use original parts. The use of non-original parts may affect your eligibility for warranty services.
2. If the filter or accessory is jammed, the vacuum will start and stop several times before shutting off. Clean the filters and the accessory before further use.
3. If the vacuum is to be left unused for an extended period, fully charge it and shut it down before storing it in a cool and dry place. Do not place the vacuum in humid locations or in direct sunlight. Charge the vacuum at least once every 3 months to prevent damage to the battery.

Cleaning the vacuum

Use a soft dry cloth to wipe the vacuum.

Emptying the dustbin

1. When the dustbin is full, suction will be reduced. Empty it before continuing with vacuuming. Before cleaning the dustbin, disconnect the vacuum from mains power and keep it switched off.

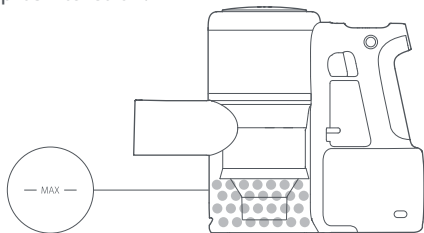

2. To empty the dustbin, push the Dustbin Opener on the front of the handle in the direction of the arrow to open it, then empty it into a bin. The dustbin should be emptied at least once a week.

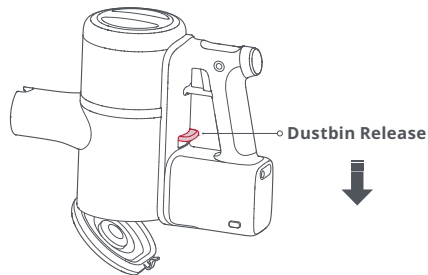

Maintenance

Cleaning the dustbin

3. Push the Dustbin Removal Latch next to the dustbin after emptying it to remove the dustbin for cleaning.

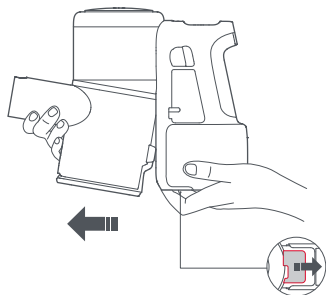

Dustbin Removal Latch

4. The dustbin should be rinsed with water at least once a month. Charging contacts should also be wiped with a soft, dry cloth once a month.

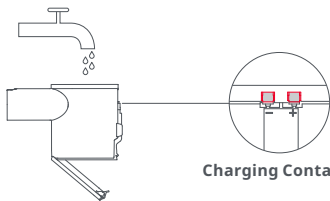

Charging Contacts

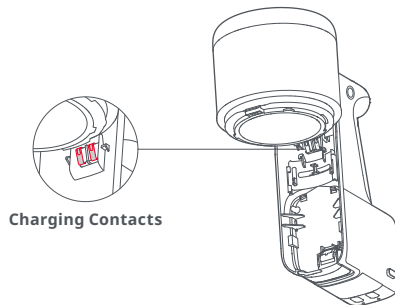

Charging Contacts

Note:

Do not clean the dustbin with detergents, polishes, or air fresheners.
Do not put the dustbin in a dishwasher or any similar appliance.

5. When the dustbin is thoroughly dry, re-install it as shown.

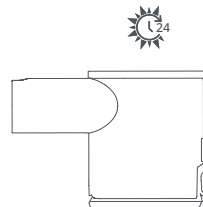

Maintenance

Dustbin Installation

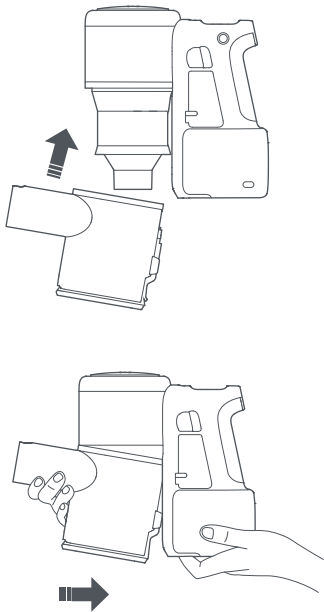

Cleaning the Front Filter and Multi-Cyclone Assembly

* Front Filter and Multi-Cyclone Assembly should be cleaned at least once a month

1. Disconnect the vacuum from power before cleaning it, and avoid squeezing the Power Trigger during cleaning.
2. Inspect and clean the Front Filter according to the manual regularly to ensure optimum vacuum performance.
3. If cleaning fine dust or operating in MAX mode, the Front Filter may require more frequent washing.

1. Remove the Dustbin as shown.

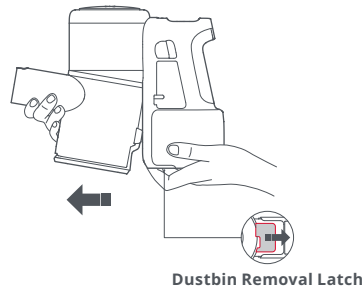

Maintenance

Removing the Front Filter and Multi-Cyclone Assembly

2. Rotate Multi-Cyclone Assembly counterclockwise as shown.

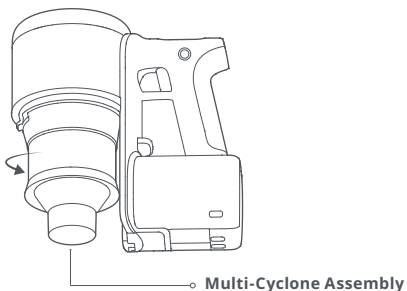

3. Remove the Front Filter.

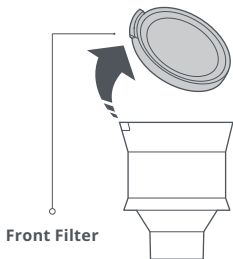

4. Rinse the Front Filter and Multi-Cyclone Assembly with cold water until clean, then allow to dry.



5. Leave 24 hours for the Front Filter and Multi-Cyclone Assembly to dry thoroughly.

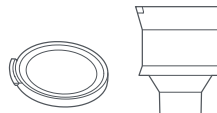

Caution:

Do not clean the filter in a dishwasher, washing machine, tumble dryer, oven, microwave, with hot air, or near a fire.

6. After drying, re-assemble the Front Filter and Multi-Cyclone Assembly.

Maintenance

Front Filter and Multi-Cyclone Assembly Installation

1. Position the Front Filter, as shown.

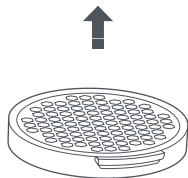

2. Place the Front Filter from the right side of the multi-cyclone assembly and lightly push it to the left to disengage the “No Filter Protection Lock”. Once the lock is nested into its slot, press down on the filter to secure it in place.

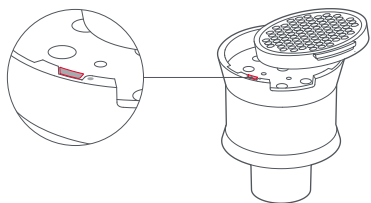

3. Align the Multi-Cyclone Array and the vacuum as shown then turn them clockwise to lock them in place.

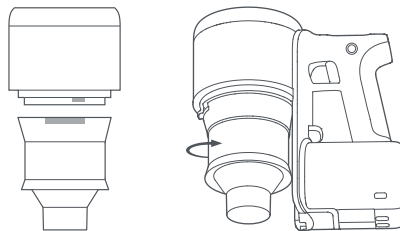

4. Tilt the dustbin and slot it back onto the vacuum.

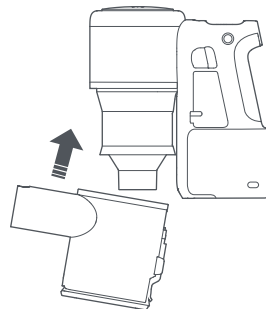

Maintenance

Front Filter and Multi-Cyclone Assembly Installation

5. Gently push the dustbin in the direction shown until you hear a click signaling that it is secured.

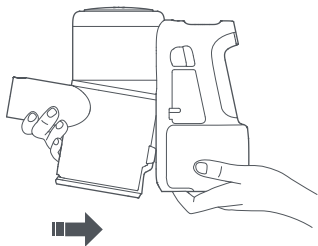

Cleaning Rear Filter

1. Remove the Rear Filter by turning it counterclockwise then pulling it off.

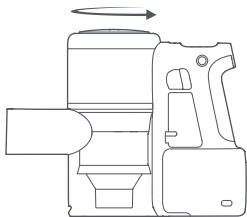

2. Rinse the inside of the Rear Filter with water, rotating it while rinsing to clean between all gaps. Lightly tap the filter against the sink after rinsing to dislodge any remaining dirty water.

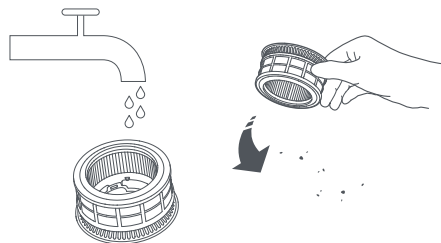

3. Repeat this process 4-5 times or until the filter is clean.

4. Allow 24 hours for the filter to dry thoroughly.



Maintenance

Cleaning Rear Filter

* Washing the Rear Filter every two months is recommended

5. When dry, reinstall the filter by aligning it with the unlock mark, slotting it into the vacuum, then turning clockwise to lock it in place.

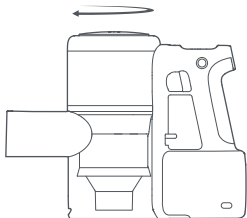

Cleaning the Rollers

Follow these instructions when inspecting and cleaning the Rollers to ensure optimum performance. Inspection and cleaning should be performed regularly. Before removing the roller, remove the accessory from the vacuum to avoid accidental damage.

Note:

Motorized Mini-Brush and Carpet brush rollers must be removed and cleaned separately. As there are electrical components and bearings in these rollers, do not wash them with water.

Cleaning the Motorized Mini-Brush

1. Hold the brush so that the locking mechanism faces you. Use a coin to turn the lock counterclockwise and remove the mechanism.

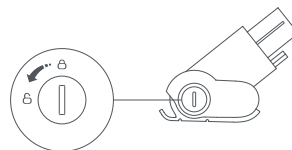

2. After removing the locking mechanism, remove the roller.

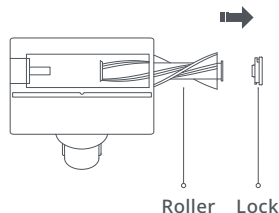

Maintenance

Cleaning the Motorized Mini-Brush

3. Clean and wash the roller



4. Place the roller vertically and leave it to dry for at least 24 hours.



5. When the roller is thoroughly dry, reinstall it.

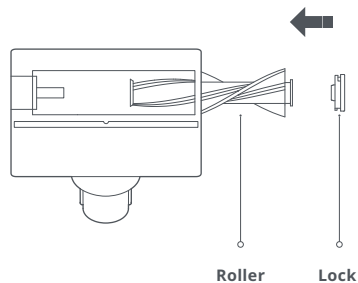

6. Hold the brush, so the locking mechanism faces you. Place the roller in position then use a coin to turn the lock counterclockwise to lock it in place.

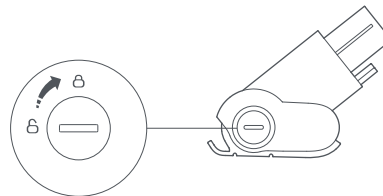

Maintenance

Cleaning the Carpet Brush

1. Hold the brush so that the locking mechanism faces you. Use a coin to turn the lock counterclockwise and remove the mechanism.



2. After removing the locking mechanism, remove the roller.

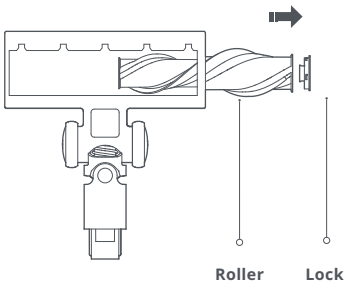

3. Take the End Cap off the roller and remove any fibers wrapped around either part.

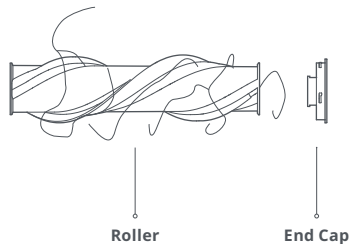

4. After cleaning, reinstall the end cap.



Maintenance

Cleaning the Carpet Brush

5. Reinstall the roller, as shown.

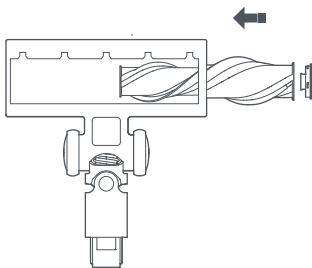

6. Hold the brush, so the locking mechanism faces you. Place the roller in position then use a coin to turn the lock counterclockwise and lock it in place.



Basic parameters

Vacuum

Name	Parameters
Model	H6M1A
Dimensions	284mm x 111mm x 221mm
Battery	22.2V/3610mAh(TYP) Lithium battery
Weight	Approx. 1.4kg
Rated Voltage	22.2V ---
Rated Power	420W



Power Supply

Name	Parameters
Model	BTC03RR
Dimensions	65.2mm x 36.3mm x 91.7mm
Rated Input	100-240V - 0.6A
Rated Output	25.6V --- 0.8A
Rated Frequency	50-60Hz

Troubleshooting

Error messages displayed onscreen

If the vacuum is not operating properly, the screen will display an error message. Check the screen and then read the table below to resolve any issues.

Error Severity	Screen	Solution
	Low battery. Recharge before use.	Low battery. Recharge before use.
	Abnormal temperature. Wait for normal battery temp.	Place vacuum in a cool place. Wait for normal battery temp.
	Abnormal temperature. Wait for normal battery temp. before recharging.	Disconnect vacuum from power and place it in a cool place. Wait for normal battery temp. before recharging.
	Check accessory. The accessory may be jammed.	Check if the accessory is jammed. See Maintenance and Warranty for details.
	Airflow blocked. The accessory or the filters may be clogged.	Check for blockages in the accessory or the filters, and empty the dustbin if it is full.
	Internal error. Contact customer support. Error code 0X	Contact customer support and provide the error code
	Charging error. Contact customer support. Error Code 0X	
	Fan error. Contact customer support. Error code 0X	

Other errors

Error	Solution
The Screen is not switching on	<ol style="list-style-type: none"> 1. Possible insufficient power. Try again after recharging. If the product is to be left unused for a prolonged period of time, fully charge it before storing it and charge to full at least every 3 months. 2. If the screen does not turn on after charging, contact customer support.
Electric brush not rotating	<ol style="list-style-type: none"> 1. The brush motor may have overheated. Let it cool before use. 2. The electric brush contact point may be dirty. Wipe it with a soft, dry cloth and retry.
Carpet Boost switches activates on hard floors	Debris may be trapped in the brush. Clear it and check that it can rotate smoothly then try again.
Suction is weak	<ol style="list-style-type: none"> 1. The Dustbin is full, and/or the filters are blocked. Empty the Dustbin and clean the filters then retry. 2. The accessory may be clogged. Clean the accessory, removing any obstructions, then retry.

EU Declaration of Conformity

Hereby we:

Manufacturer	Beijing Roborock Technology Co., Ltd.
Address	Floor 6, Suite 6016, 6017, 6018, Building C, Kangjian Baosheng Plaza, No.8 Heiquan Road, Haidian District, Beijing P.R. CHINA

declare that this DoC is issued under our sole responsibility and that the products:

Product description	Handheld Vacuum Cleaner and Accessories
Type(model) designation(s)	H6M1A

are in conformity and verified through testing with the provision of the following EU directives:

Low Voltage Directive 2014/35/EU 1.EN 60335-1:2012+A11+A13+A1+A2+A14 2.EN 60335-2-2:2010+A1+A11 3.EN 62233:2008	1.Household and similar electrical appliances-Safety-Part 1: General requirements 2.Household and similar electrical appliances-Safety-Part 2-2: Particular requirements for vacuum cleaners and water suction cleaning appliance 3.Measurement methods for electromagnetic fields of household appliance and similar apparatus with regard to human exposure
--	---

EU Declaration of Conformity

<p>EMC Directive 2014/30/EU 1.EN 55014-1:2006+A1+A2 EN 55014-1:2017 2.EN 55014-2: 2015 3.EN IEC 61000-3-2: 2019 4.EN 61000-3-3: 2013</p>	<ol style="list-style-type: none"> 1. Electromagnetic Compatibility-Requirements for household appliances, electric tools and similar apparatus Part 1: Emission 2. Electromagnetic compatibility – Requirements for household appliances, electric tools and similar apparatus Part 2: Immunity – Product family standard 3. Electromagnetic compatibility (EMC) - Part 3-2: Limits - Limits for harmonic current emissions (equipment input current \leq 16 A per phase). 4. Electromagnetic compatibility (EMC) - Part 3-3: Limits - Limitation of voltage changes, voltage fluctuations and flicker in public low-voltage supply systems, for equipment with rated current \leq 16 A per phase and not subject to conditional connection.
<p>RoHS Directive 2011/65/EU EN50581:2012</p>	<p>Technical documentation for the assessment of electrical and electronic products with respect to the restriction of hazardous substances.</p>
<p>Product description</p>	<p>Power Supply and Accessories</p>
<p>Type(model) designation(s)</p>	<p>BTC03RR</p>

are in conformity and verified through testing with the provision of the following EU directives:

EU Declaration of Conformity

<p>Low Voltage Directive 2014/35/EU 1.EN 61558-1:2005+A1:2009 2.EN 61558-2-16:2009+A1:2013</p>	<p>1.Safety of power transformers, power supplies, reactors and similar products -Part 1: General requirements and tests 2.Safety of transformers, reactors, power supply units and similar products for supply voltages up to 1 100 V – Part 2-16: Particular requirements and tests for switch mode power supply units and transformers for switch mode power supply units</p>
<p>EMC Directive 2014/30/EU 1.EN 55014-1:2006+A1+A2 EN 55014-1:2017 2.EN 55014-2: 2015 3.EN IEC 61000-3-2: 2019 4.EN 61000-3-3: 2013</p>	<p>1. Electromagnetic Compatibility-Requirements for household appliances, electric tools and similar apparatus Part 1: Emission 2. Electromagnetic compatibility – Requirements for household appliances, electric tools and similar apparatus Part 2: Immunity – Product family standard 3. Electromagnetic compatibility (EMC) - Part 3-2: Limits - Limits for harmonic current emissions (equipment input current \leq 16 A per phase). 4. Electromagnetic compatibility (EMC) - Part 3-3: Limits - Limitation of voltage changes, voltage fluctuations and flicker in public low-voltage supply systems, for equipment with rated current \leq 16 A per phase and not subject to conditional connection.</p>
<p>Erp Directive 2009/125/EC EN 50563:2011+A1</p>	<p>Technical documentation for the assessment of electrical and electronic products with respect to the restriction of hazardous substances</p>
<p>RoHS Directive 2011/65/EU EN50581:2012</p>	<p>Technical documentation for the assessment of electrical and electronic products with respect to the restriction of hazardous substances.</p>

EU Declaration of Conformity ((EU) 2019/1782)

Information published	Value and precision	Unit
Beijing Roborock Technology Co., Ltd. Address: Floor 6, Suite 6016, 6017, 6018, Building C, Kangjian Baosheng Plaza, No. 8 Heiquan Road, Haidian District, Beijing P.R. CHINA commercial registration number: 91110108306467260B	—	—
Power Supply Model: BTC03RR	—	—
Input voltage	100-240	V-
Input AC frequency	50-60	Hz
Output voltage	25.6	V ---
Output current	0.8	A
Output current	20.5	W
Average active efficiency	89.7	%
Average active efficiency	83.9	%
No-load power consumption	0.07	W

Person responsible for making this declaration:

Printed name: Rui.Shen

Position/Title: Quality Director

Signature: Rui.Shen

Date of issue: February 11, 2020

Please of issue: Floor 6, Suite 6016, 6017, 6018, Building C, Kangjian Baosheng Plaza, No. 8 Heiquan Road, Haidian District, Beijing P.R. CHINA

WEEE Information

Correct Disposal of this product . This marking indicates that this product should not be disposed with other household wastes throughout the EU. To prevent possible harm to the environment or human health from uncontrolled waste disposal, recycle it responsibly to promote the sustainable reuse of material resources. To return your used device, please use the return and collection systems or contact the retailer where the product was purchased. They can take this product for environmental safe recycling.

Korrekte Entsorgung dieses Produkts Innerhalb der EU weist dieses Symbol darauf hin, dass dieses Produkt nicht über den Hausmüll entsorgt werden darf. Altgeräte enthalten wertvolle recyclingfähige Materialien, die einer Wiederverwertung zugeführt werden sollten und um der Umwelt bzw. der menschlichen Gesundheit nicht durch unkontrollierte Müllbeseitigung zu schaden. Bitte entsorgen Sie Altgeräte deshalb über geeignete Sammelsysteme oder senden Sie das Gerät zur Entsorgung an die Stelle, bei der Sie es gekauft haben. Diese wird dann das Gerät der stofflichen Verwertung zuführen.



Warranty Information

The warranty period depends on the laws of the country in which the product is sold, and the warranty is the responsibility of the seller.

The warranty only covers defects in material or workmanship.

The repairs under warranty may only be carried out by an authorized service centre.

When making a claim under the warranty, the original bill of purchase (with purchase date) must be submitted.

The warranty will not apply in cases of:

Normal wear and tear
Incorrect use, e.g. overloading of the appliance, use of non-approved accessories
Use of force, damage caused by external influences
Damage caused by non-observance of the user manual, e.g. connection to an unsuitable mains supply or non-compliance with the installation instructions
Partially or completely dismantled appliances.



Roborock handheld cordless vacuum cleaner

Manufacturer: Beijing Roborock Technology Co., Ltd.

Product Model: H6M1A

Address of Manufacturer: Floor 6, Suite 6016, 6017, 6018, Building C, Kangjian Baosheng Plaza,
No.8 Heiquan Road, Haidian District, Beijing, P.R.CHINA

For more product information, visit our website: www.roborock.com

For after-sales support, email our after-sales service team:

US/Non-Europe Support: support@roborock.com

Europe Support: support@roborock-eu.com