

# Roborock Wet and Dry Vacuum Cleaner User Manual

Read this manual carefully before using this product and store it properly for future reference.



# Contents

005	Safety Information
008	Product Introduction
011	Instructions for Use
015	Routine Maintenance
017	Basic Parameters
017	Troubleshooting
018	Common Issues
019	EU Declaration of Conformity
019	WEEE Information
019	Warranty Information

# Safety Information

## Usage Restrictions

- Do not use this vacuum outdoor or in any commercial or industrial environments. It is intended for home use only.
- Do not store the vacuum anywhere in a car to avoid high or low temperatures affecting its battery life.
- Do not use the vacuum in environments with high humidity, or temperatures above 40°C or below 4°C.
- Children should be supervised to ensure that they do not play with the appliance.
- This appliance is not intended for use by persons (including children) with reduced physical, sensory or mental capabilities, or lack of experience and knowledge, unless they have been given supervision or instruction concerning use of the appliance by a person responsible for their safety (CB).
- This appliance can be used by children aged from 8 years and above and persons with reduced physical, sensory or mental capabilities or lack of experience and knowledge if they have been given supervision or instruction concerning use of the appliance in a safe way and understand the hazards involved. Children shall not play with the appliance. Cleaning and user maintenance shall not be made by children without supervision (EU).

# Safety Information

- Keep hair, loose clothing, fingers, and all parts of body away from openings and moving parts.
- Keep limbs and pets away from the rotating brush heads to avoid injury.
- Do not touch the power supply, nor operate the product with wet hands to prevent injuries.
- Do not vacuum any burning or smoking substances (such as non-extinguished cigarette butts).
- Do not vacuum any hard or pointy objects (such as building materials, glass, and nails).
- Please use this product in accordance with the instructions in the User Manual. Users are responsible for any loss or damage that may arise from improper use of this product.
- This product is only to be used in areas below 3,000 meters above sea level.

## Battery and Charging

### WARNING

- Do not charge non-rechargeable batteries.
- This product contains batteries that are only replaceable by skilled persons.

## Safety Information

- This product can only be charged using a S036-1A256140HA or S036-1A256140HE power supply provided with the product.
- Do not use any third-party batteries, power adapters or docks.
- Do not disassemble, repair or modify the battery, power adapter or the dock.
- Do not charge the vacuum or install the dock near heat sources or in humid areas (such as radiators or bathrooms).
- Do not wipe the adapter or the dock with a wet cloth, nor touch them with wet hands.
- If the power cord is damaged or broken, immediately stop use and contact after-sales service.
- If the vacuum is not going to be used for an extended period of time, fully charge it, unplug its power supply, and place it in a cool and dry place.
- Make sure that you recharge it once every three months to avoid the battery to over-discharge.

## Transportation

- It is recommended to transport the vacuum in its original packaging.

## Note

- Rinse the filter at least once a month with tap water. For details please refer to Maintenance.

# Product Introduction

## Body

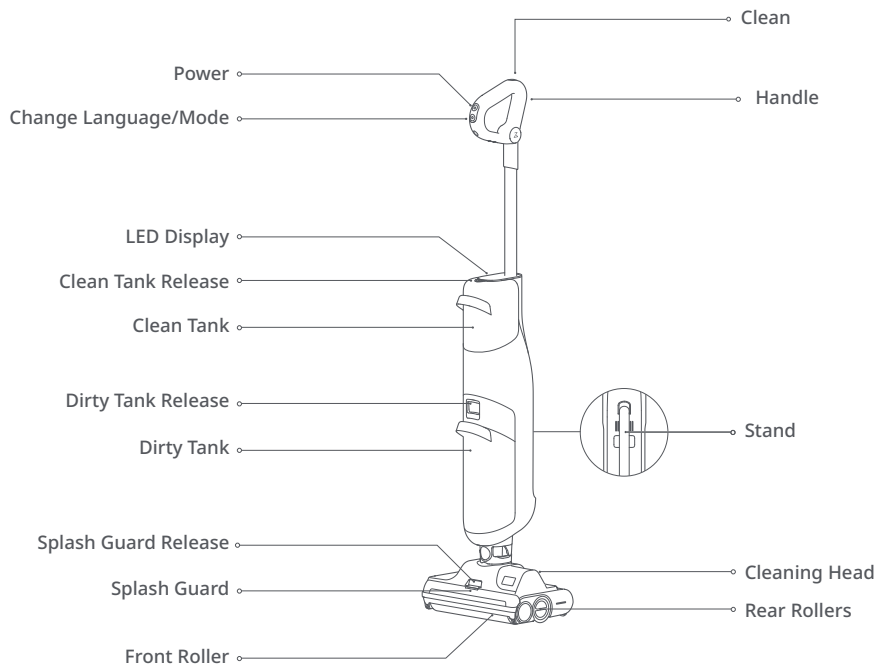

# Product Introduction

## Accessories

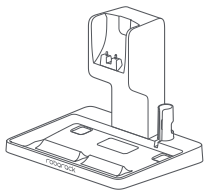

Dock



Maintenance  
Brush

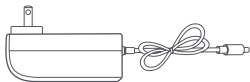

Power Supply

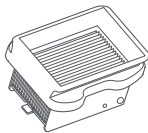

Filter

## Screen Functions

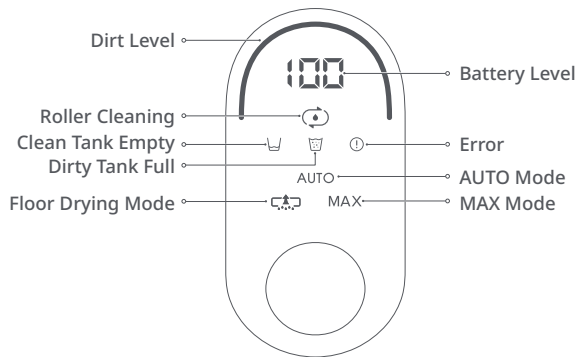

# Product Introduction

## Setting Up the Vacuum

1. Insert the end of the handle into the vacuum body as shown until it clicks in place. Note that the Power button should face forwards.
2. To remove the handle, gently pull it while inserting a pin into the hole on the back of the vacuum body to press the release button.

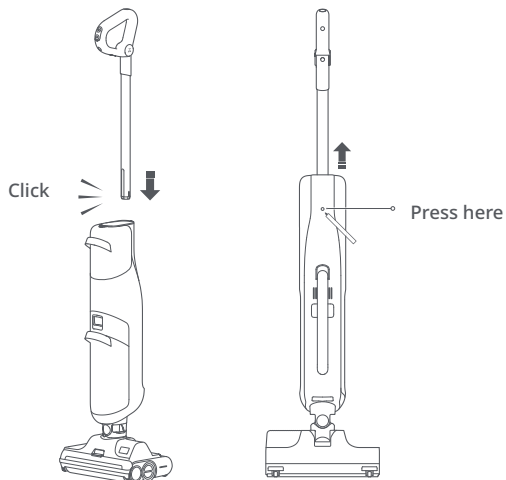

## Charging Dock Installation

1. Connect upper and lower parts of the charging dock as shown, making sure they are firmly secured.

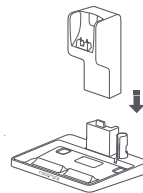

2. Connect the power supply into the back of the charging dock and plug it in. Wrap any excess cord around the cable management pins on the back of the dock.
3. To disassemble, press the release on the back of the dock and pull to separate the upper and lower parts.

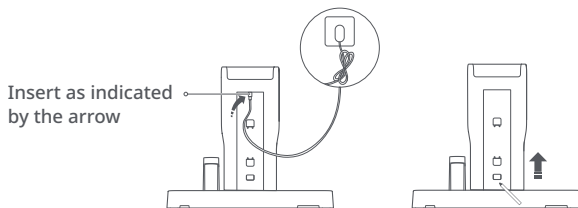



# Instructions for Use

## Filling the Clean Water Tank

1. Push the Clean Tank Release and remove the clean tank.
2. Turn the clean tank upside down and open the plug. Add enough clean water to clean the required area. If deep cleaning, add the Roborock floor cleaner diluted according to the guidance on the cleaner bottle. Do not add excessive cleaner.

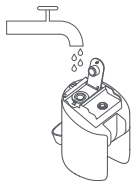
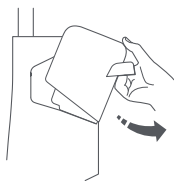

3. Close the water tank cover and make sure that it is in place.
4. Reinstall the clean tank bottom first then push inward to secure it in place.

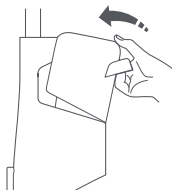
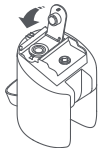

### Notes:

- To prevent corrosion, only use cleaning solution provided by Roborock.
- To avoid deforming the water tank, only use cold water.

## Starting the Vacuum

1. Tilt the body to a comfortable angle and press Power to start the vacuum. The current battery and mode are displayed in the center of the screen, and the dirt level is indicated at the top.
2. To prevent dirty water from leaking out, keep the vacuum upright. Do not lay it flat.



**Note:** Power cannot be used when the vacuum cleaner is charging.

# Instructions for Use

## Switching Modes

1. Press Change Language/Mode to switch between AUTO and MAX modes.
2. Press and hold Change Language/Mode for 3 seconds to switch to Floor Drying mode. To return to AUTO mode, press Change Language/Mode again. The screen will display the icon for the current mode.

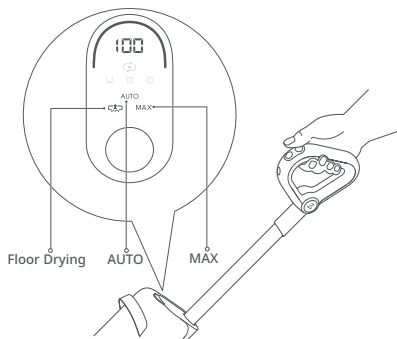

### Notes:

- Floor Drying mode is for removing clean water from wet environments such as bathrooms. It should not be used when water depth exceeds 10mm (0.4in).
- Floor Drying mode is limited to one minute. After which, AUTO mode will resume.

## Stopping

When the vacuum cleaner is in use, press Power to return it to standby mode.

## Adding and Emptying Water

When the dirty tank fills up or the clean tank empties during use, the vacuum cleaner will automatically stop operating and provide an audio or visual prompt. Add water into the clean tank or empty the dirty tank as required before continuing.

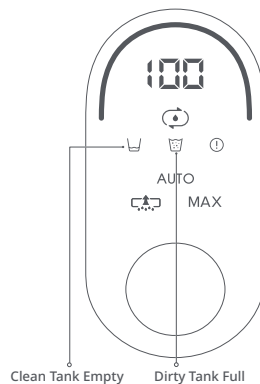

# Instructions for Use

## Emptying the Dirty Tank

1. Push the Dirty Tank Release and remove the tank.
2. Hold the handle firmly with one hand and gently lift off the cover.

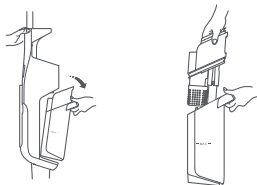

3. Pour out the dirty water, then remove and empty any dirt from the filter cartridge at the bottom of the cover.
4. Reinstall the filter cartridge and put the cover back on.
5. Tilt the dirty tank as shown, then tilt it upwards to lock it in place.

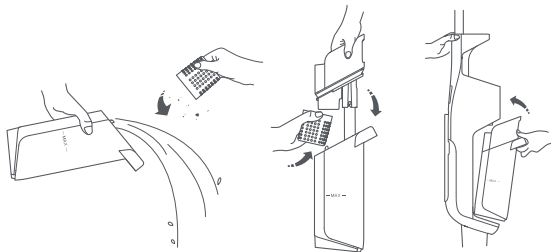

**Note:** The filter cartridge prevents dirt from blocking the water pipe. It can be removed if it is deemed unnecessary.

## Standby and Power Off

When stopped, the vacuum will go into standby, and its screen will display the battery level and current mode. It will turn off entirely if left idle for 5 minutes in standby.



# Instructions for Use

## Charging and Self-Cleaning \* Self-clean after every use.

Place the vacuum upright into the charging dock. The voice prompt "Charging" indicates that it has been placed securely.

1. Press Clean on the top of the handle to start self-cleaning. This takes approximately 2 minutes.
2. Empty the dirty tank after Self-Cleaning is complete.

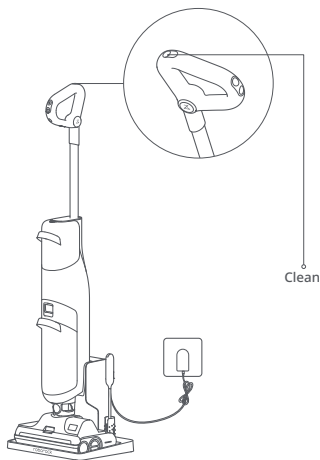

### Notes:

- Always place the vacuum on the charging dock after use to prevent water stains.
- If the vacuum is off, press Power to turn it on before starting self-cleaning.

## Turning Voice Alerts On/Off

Press both Clean and Change Language/Mode buttons for 3 seconds while in standby mode to turn on/off voice alerts.

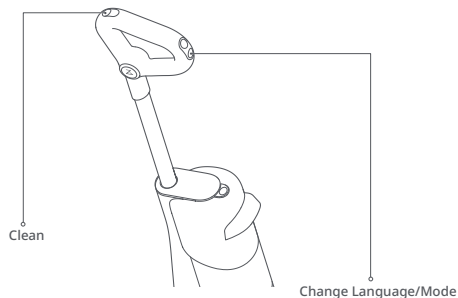

## Changing Voice Alert Language

Place the vacuum on the charging dock, then press and hold Change Language/Mode for 10 seconds to enter language selection. Press Change Language/Mode to switch between languages. Stop when you hear the desired language then press and hold Change Language/Mode for 5 seconds to select it and exit language selection. Press Power to exit without selecting.

# Routine Maintenance

## Product Maintenance

1. Only use official parts. Warranty services may not be available if any unauthorized replacements are used.
2. If this product will not be used for a long time, fully charge it and unplug it before storing it in a cool, dry place. Do not store it where it can be exposed to direct sunlight or dampness. Fully recharge it at least once every 3 months to avoid over-discharging the battery.

## Cleaning the Vacuum

Wipe the vacuum with a soft, dry cloth. Unplug the power supply and ensure that the vacuum is off before cleaning.

## Cleaning the Dirty Tank and Filter \* Clean weekly.

1. Take out the dirty tank, lift off the cover, empty any dirty water, then remove the filter cartridge at the bottom of the cover.
2. Remove any dirt stuck to the tank and clean the filter cartridge with the provided maintenance brush.
3. Rinse the filter out with cold water, then shake off excess water.
4. Leave parts to dry before reinstalling them.

### Notes:

- Allow up to 24 hours for filter drying. Use a second filter if necessary.
- Do not touch the filter with your hands, brushes, or sharp objects to avoid filter damage.



## Cleaning the Rollers \* Clean weekly.

1. Remove the vacuum from the dock, making sure to keep it switched off. Flip out the stand and place the vacuum securely.
2. Push the Splash Guard Release and pull the cover outward to remove it.
3. Pull out the front roller using the release on the left.

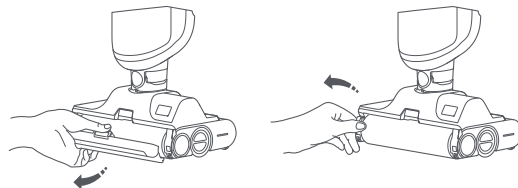

4. Pinch the left and right rear rollers with both hands, and rotate them as shown while pulling them in the indicated direction.

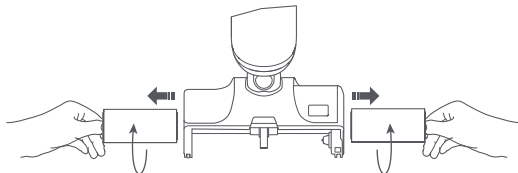

# Routine Maintenance

5. Cut away any entangled hair and remove any embedded debris using the provided maintenance brush.
6. Pull off the roller's side cap, remove any entangled hair, and put it back in place.

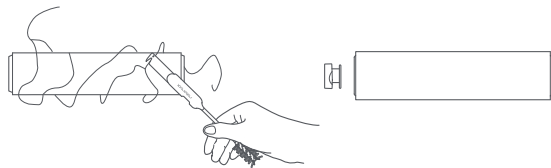

4. Pinch the left and right rear rollers with both hands and align them with the rear roller shaft. Rotate the rollers as shown while pushing inward to install.

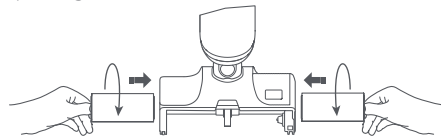

## Reinstalling the Rollers

1. To reinstall the front roller, line up the right side with the roller shaft, then push the left side into its slot.
2. To reinstall the splash guard, insert the hooks at either side of the guard into the corresponding holes on the head, then press the splash guard until it clicks in place.
3. To install the rear rollers, place the left and right rollers, marked red and blue respectively, on the correct sides of the head.

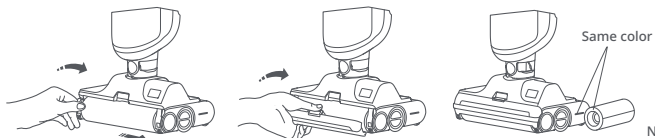

## Cleaning the Head and Dirty Water Hose

\* Clean weekly.

1. Flip out the stand and place the vacuum securely. Remove the dirty tank and all the rollers.
2. Clean the roller brush slot and the dirty water pipe with the maintenance brush provided.
3. Reinstall the rollers and the dirty tank.

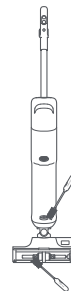

**Note:** Do not wash the cleaning head directly with water.

# Basic Parameters

## Body

Model	WD1S1A
Dimensions	1112mm x 270mm x 191mm
Weight	5 kg
Rated power	260 W
Rated voltage	21.6 V --- /22.2 V ---
Charging time	< 4 hours
Battery	22.2 V/5130 mAh(TYP) Lithium-ion battery 21.6 V/5000 mAh(TYP) Lithium-ion battery

## Power Supply

Model	S036-1A256140HE or S036-1A256140HA
Rated input	100–240 V~50/60 Hz, 1.0 A
Rated output	25.6 V ---1.4 A
Battery	22.2 V/5130 mAh(TYP) Lithium-ion battery 21.6 V/5000 mAh(TYP) Lithium-ion battery

# Troubleshooting

If an error occurs during operation, the vacuum will stop operating and play a voice alert. Follow the instructions provided by the alert.

<b>Error</b>
Error 1: Low battery. Recharge now.
Error 2: Clean water tank empty. Refill now.
Error 3: Dirty water tank full. Empty now.
Error 4: Remove blockages from the cleaning head.

For after-sales support, contact our support team at:  
Europe: [support@roborock-eu.com](mailto:support@roborock-eu.com)  
Australia: [service@roborock.com.au](mailto:service@roborock.com.au)

# Common Issues

Issue	Solution
The screen does not turn on. Vacuum does not start.	<ul style="list-style-type: none"><li>• Low battery. Recharge before use.</li></ul>
Dirty water is not vacuumed from the floor.	<ul style="list-style-type: none"><li>• Remove the rollers and the dirty tank to check for a clog in the dirty water pipe or the suction outlet, and if the filter is clogged. Clear all blockages, clean the filter and make sure dirty tank and filter were properly installed before retrying.</li></ul>
There is a strange smell during use.	<ul style="list-style-type: none"><li>• Clean the rollers, dirty water tank, and the filter.</li></ul>
The vacuum cleaner does not charge when docked.	<ul style="list-style-type: none"><li>• Check the charging contacts on the charging dock and the corresponding part on the body.</li></ul>
Cleaning creates a lot of bubbles.	<ul style="list-style-type: none"><li>• Only use Roborock cleaning solutions with the vacuum. Do not add other cleaning solutions in the water tank or on the floor.</li></ul>
The screen is on, but the buttons do not respond.	<ul style="list-style-type: none"><li>• Press and hold Power for 5 seconds to force restart the vacuum.</li></ul>
Clean Water Tank Empty voice alert persists after refilling the tank.	<ul style="list-style-type: none"><li>• Use tap water only. Do not use purified water.</li></ul>



# EU Declaration of Conformity

We Shenzhen Roborock Innovation Technology Co., Ltd., hereby, declares that this equipment is in compliance with the applicable Directives and European Norms, and amendments. The full text of the EU declaration of conformity is available at the following internet address:  
<https://global.roborock.com/pages/compliance>

## WEEE Information

Correct Disposal of this product. This marking indicates that this product should not be disposed with other household wastes throughout the EU. To prevent possible harm to the environment or human health from uncontrolled waste disposal, recycle it responsibly to promote the sustainable reuse of material resources. To return your used device, please use the return and collection systems or contact the retailer where the product was purchased. They can take this product for environmental safe recycling.



## Warranty Information

The warranty period depends on the laws of the country in which the product is sold, and the warranty is the responsibility of the seller.

The warranty only covers defects in material or workmanship.

The repairs under warranty may only be carried out by an authorized service centre. When making a claim under the warranty, the original bill of purchase (with purchase date) must be submitted.

The warranty will not apply in cases of:

- Normal wear and tear.
- Incorrect use, e.g. overloading of the appliance, use of non-approved accessories, use of force.
- Damage caused by external influences.
- Damage caused by non-observance of the user manual, e.g. connection to an unsuitable mains supply or non-compliance with the installation instructions.
- Partially or completely dismantled appliances.