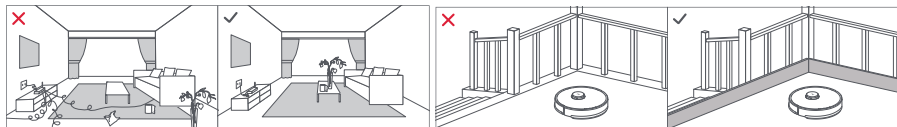
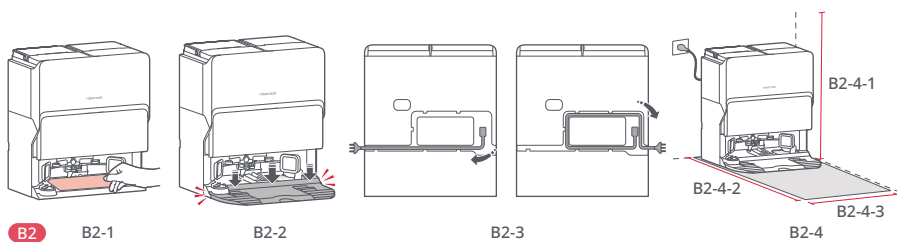

B**B1**

B1-1

B1-2

**B2**

B2-1

B2-2

B2-3

B2-4

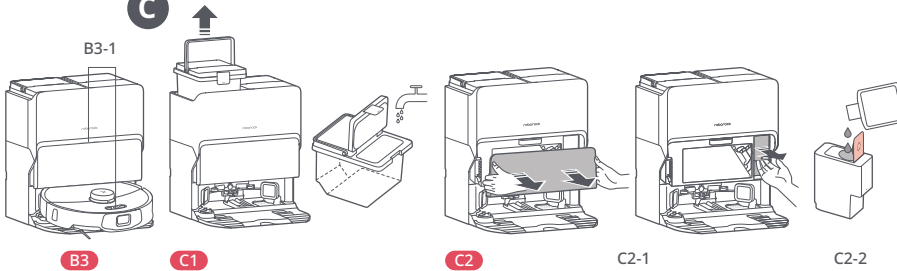
C**B3****C1****C2**

C2-1

C2-2

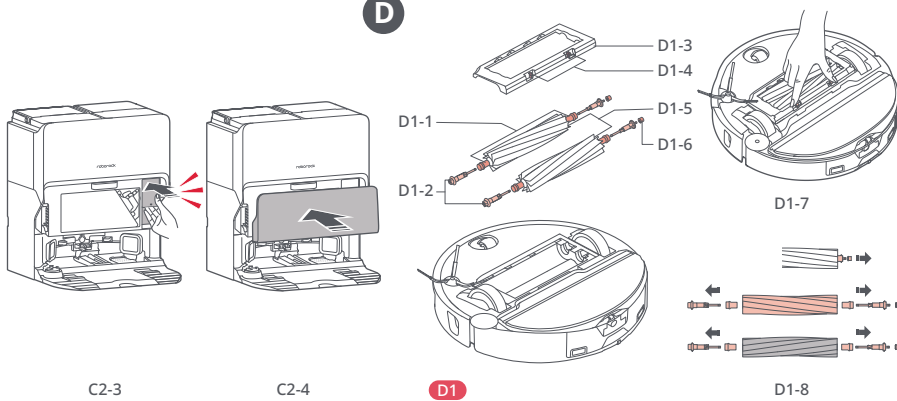
D

C2-3

C2-4

D1

D1-8

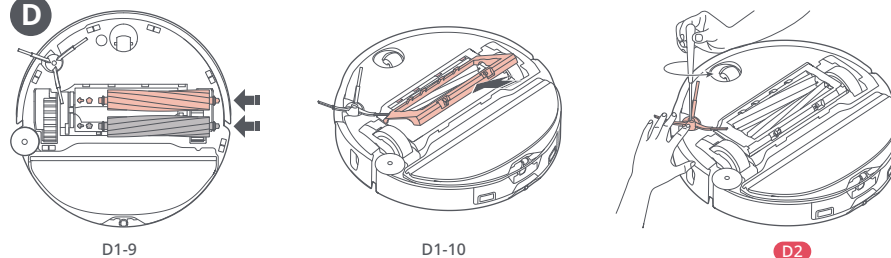
D

D1-9

D1-10

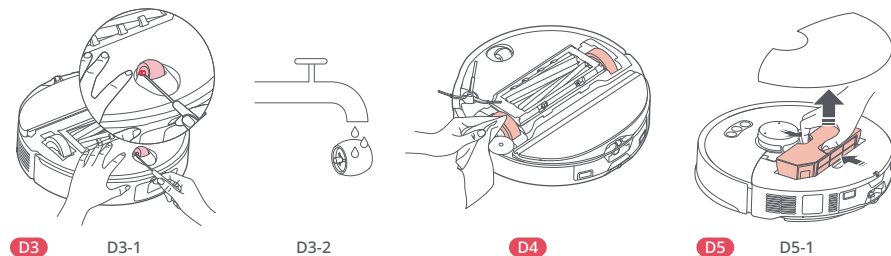
D2**D3**

D3-1

D3-2

D4**D5**

D5-1

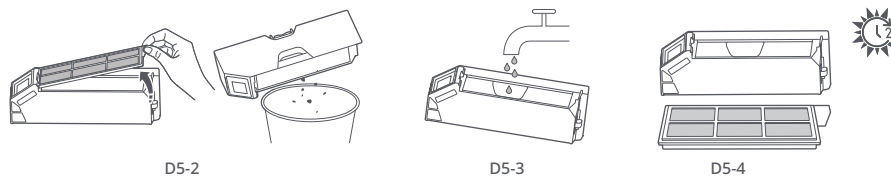

D5-2

D5-3

D5-4

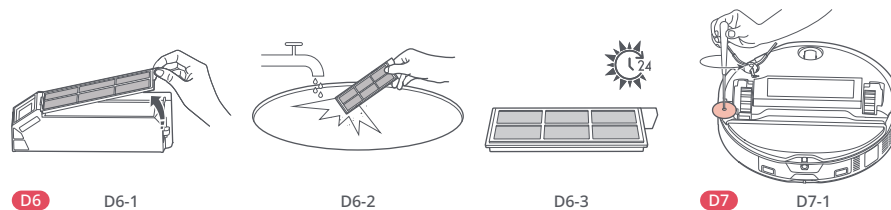
**D6**

D6-1

D6-2

D6-3

D7

D7-1

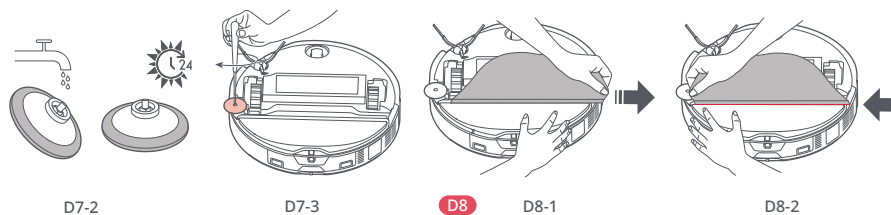

D7-2

D7-3

D8

D8-1

D8-2